

User Manual

SLAN

FOCUS

Please read carefully before use

Please Note: Specifications and improvements in the design of this unit and this manual are subject to change without any prior written notice.

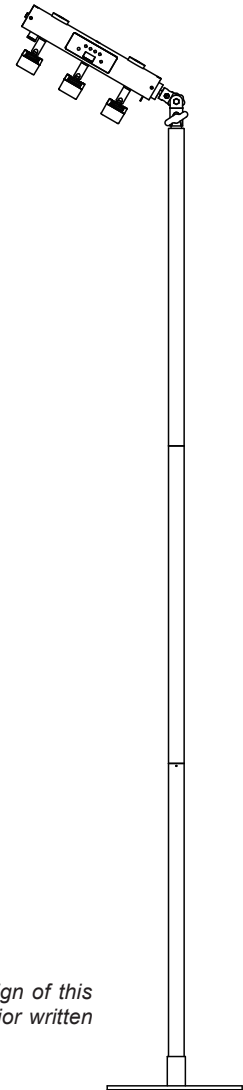

Introduction

Packaging: Thanks for your purchasing the Focus. All the lights have been checked and are in excellent operating condition. Please check the shipping carton first, because there may be damage occurred during the shipment. Then check the lights carefully and be sure that the lights is intact and works normally. In the event damage has been found, spare parts are missing or the lights works abnormally, please contact us for further instructions. And please don't return the lights to the dealer before contacting us.

Introduction: The Focus has three operating modes: DMX mode, Auto mode and Master/Slave mode. And the lights has four DMX modes, including channel 2, channel 5, channel 8, and channel 10. In addition, you can connect several pieces of lights in DMX mode and set one in Auto mode, and the others in Master/Slave mode. And then all the lights in Master/Slave mode will run following the one in Auto mode. Using fog or special effect smoke, you can see better showing effect.

SAFETY AND HANDLING

Before you operate this unit read the manual carefully. Always make sure to include the manual if you pass/rent/sell the unit to another user. Keep in mind that this manual cannot address all possible dangers and environments. Please use your own caution when operating. This product is for professional use only. It is not for household use.



- Do not operate the unit in areas of high temperature conditions. It will cause abnormal function or damage the product.
- Always use a suitable safety wire when mounting the light overhead.
- Connect the safety wire only to the intended safety mount.
- Always follow local safety requirements.











- Only qualified personnel may repair this product.
- Do not open the product housing.
- Do not apply power if the light is damaged.

3. Turn on the light and enter [SETUP]→[REMOTE]→[ON], press the [ENTER] key to enter the matching mode. (If [ON] is displayed in the [REMOTE] mode during startup, you need to press the [ENTER] key again to enter the matching mode.)
4. During the flashing of the remote control light, the lamp flashes 3 times, which means that the connection is successful.
5. After the match is successful, when the remote control light is on, it means that the group of lamps is being controlled.
6. If there are multiple lamps that need to be connected, please repeat the above steps and press the  button to select different groups for connection. (Each group can connect up to 50 lamps.)
7. The furthest remote control distance of this product is about 30 meters. No need to rematch after power failure.

2.4G Remote



-  Power on/off button
Press and hold the power button for 3 seconds to turn on/off the remote control , short press the control light switch
-  DMX button,to control DMX address when press this button.It is SLAVE mode when double click.
-  The first one is Auto Mode.It is Speed mode when double click.
-  The first one is Sound Mode.It is Speed mode when double click.
-  Strobe mode button
-  Up and down button,you can choose the program that you need or numerical.
-  Switching group button
Press and hold the button for 5 seconds to enter matching mode

1 2 3 4 Group indicator light  Press color button enter color menu

      Color choosing button.

!!For the version WW+CW,the  button on the remote control is the warm white effect, and the  button is the cold white effect.

       

You can use these number button to adjust numerical in any program mode.

How to connect 2.4G remote control

1. Press and hold the  button for 3 seconds to turn on or off the power of the remote control (the indicator light indicates that the remote control is turned on, and the remote control power will be automatically turned off after 1 minute of no operation).

!!The indicator light will automatically turn off after 1 minute of use and need to be pressed again for 3 seconds to turn on again.

2.Press and hold the  button for 5 seconds, the indicator blinks, enters the matching mode, and automatically exits the pair mode after 20 seconds.



- Do not directly look into the light.
- It can cause harm to your eyes.
- Do not look at the LEDs with a magnifying glass or any other optical instrument that may concentrate the light output.



- The exterior surfaces of the light can become hot, up to 70°C during normal operation.
- Ensure that accidental physical contact with the device is impossible.
- Install only in ventilated locations.
- Do not cover the light.



- LI-ION Battery: A rechargeable lithium ion battery is built into this unit.
- Only authorized personal may service the battery.
 - Do not place in fire or heat.
 - Do not use or charge the light if it is damaged.
 - Avoid bumping or plunging, it may cause fire or explosion.
 - Never store the battery when fully drained.
 - Always recharge immediately when empty.
 - Make sure to fully charge all units before storing them.
 - Partially charged batteries will lose capacity.
 - The battery may only be replaced with an original spare part.



- Always charge with the flight case open.
- It is recommended to charge at a temperature between 15°C and 35°C



- The light contains a lithium ion battery.
- Don't throw the unit into the garbage at the end of its lifetime.
- Make sure to dispose is according to your local ordinances and/or regulations, to avoid polluting the environment!
- The packaging is recyclable and can be disposed.

Troubleshooting

The fixture does not turn on.

The battery may be empty. Connect it to the power cable and try again.

The fixture turns on and the display is on, but the LEDs do not emit light.

The fixture could be set to BLACKOUT mode, set to is DMX Hold and doesn't receive a valid signal. It is good practice to do a Factory Reset.

The fixture is not working correctly - it does not display the color or effect chosen.

The fixture may still be operating under a previous setting. It is good practice to do a Factory Reset.

After completing a RESET SETTINGS, the fixture still cannot be controlled.

Please turn off the light and turn on again, if cannot be controlled, too, please consult authorized personal.

The fixture does not run long enough on battery.

The required RUNTIME can be set. It defaults to several hours. To achieve a greater battery runtime, set the RUNTIME to the required value.

Alternatively, program the fixture to only display colors that use less power, such as Red, Green, Blue and White.

If the runtime is still too short, consider that it is reduced slightly if the battery is very cold.

The power cable is connected but the fixture is not charging.

The battery may be fully charged. Please read our user manual for more details. The fixture will only commence charging when its battery has a temperature of 45° or less. Turn the fixture off and let it cool down; once cold enough, it will start charging. If it still not charging, please consult authorized personal.

Tips & tricks

There are limitations to how wireless waves propagate through air. Physical barriers like glass, concrete and walls will limit the transmission range. Always try to have clear line-of-sight between transmitters and receivers.

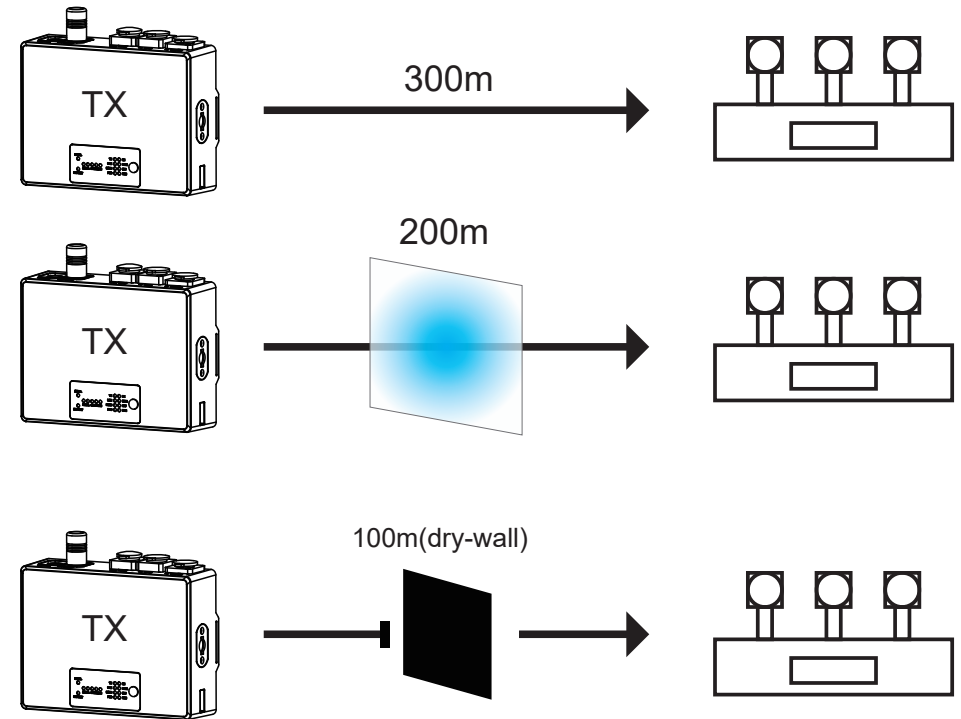

Wireless indicator status	Description
Both blinking red color	wireless transmitter or receiver OFF or not linked with the projector
Both blinking but: Wireless green	Master and Slave with the projector not connect success
Both fixed green color	Master-Transmitter mode ON and linked with the projector Slave- Receiver

Connection in wireless mode -DMX



When connection wireless mode, please remember release first.

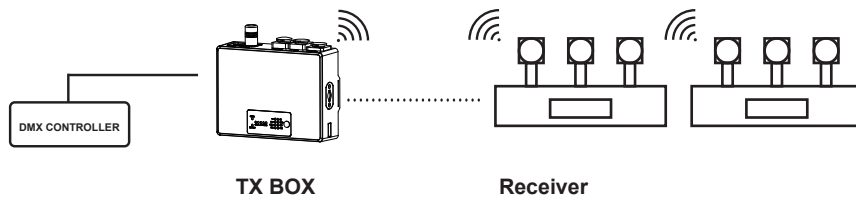

DMX led status and wireless indicator	Description
Both blinking red color	DMX not connected e wireless transmitter OFF or not linked with the projector
Both blinking but: DMX red - Wireless green	DMX not connected,transmitter ON and linked with the projector
Both fixed green color	Dmx connected,transmitter ON and linked with the projector

Mechanical Specification

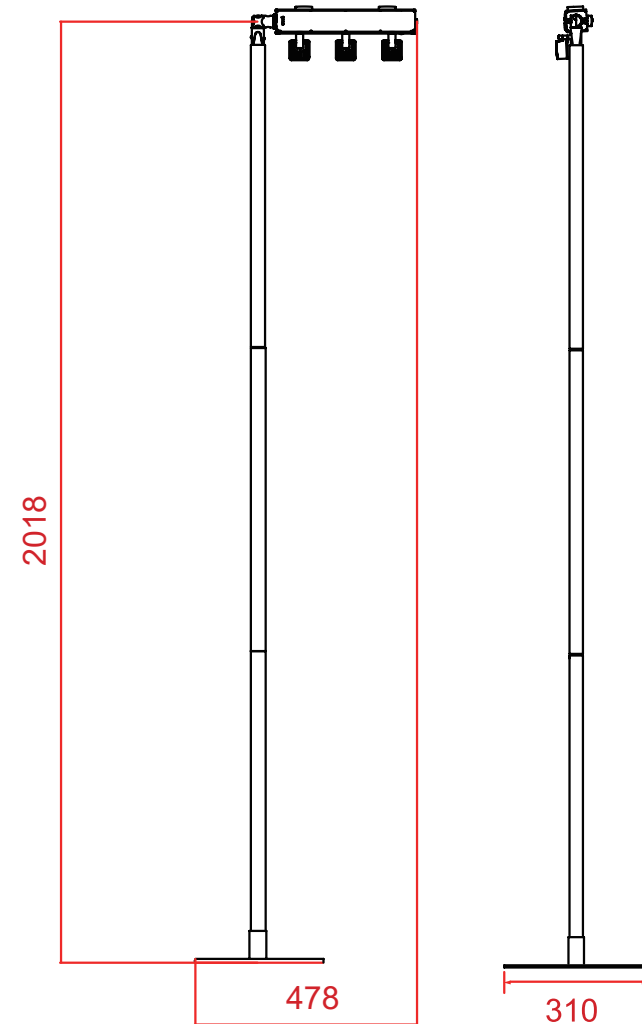

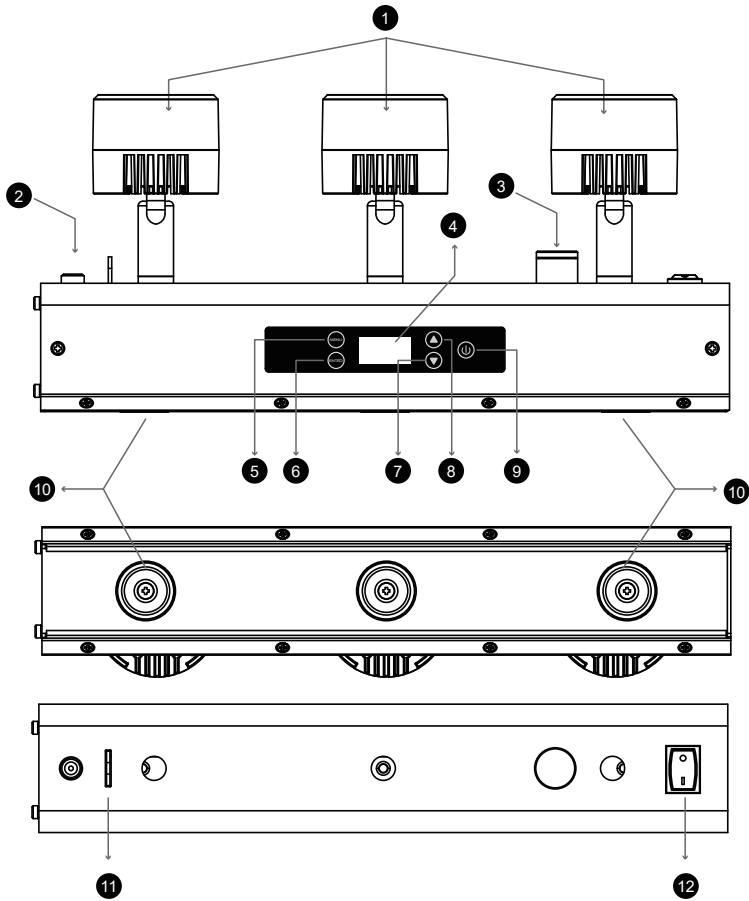

- | | |
|-------------|-------------------------|
| 1. Lamp | 8. UP |
| 2. DC Input | 9. Switch ON/OFF |
| 3. Wireless | 10. Magnet fixing parts |
| 4. Display | 11. Safety buckle |
| 5. Menu | 12. ON/OFF |
| 6. Enter | |
| 7. Down | |

CHARGE WITH ABS CASE



DURING THE COMPLETE PROCESS OF BATTERIES CHARGE THE UPPER COVER OF THE FLIGHTCASE MUST BE ALWAYS OPEN.



DURING THE COMPLETE PROCESS OF BATTERIES CHARGE THE PROJECTORS MUST BE ALWAYS OFF.

For correct use of the battery it is strongly recommended to:

- Charge the battery at least one time each month
- The minimum level of the charge must be not less than 5%

During the charge, the battery icon (visible on the display) will show the level of the charge. When the charge is finished, the icon will be totally green.

Connection in wireless mode - Master/Slave



When connection wireless mode, please remember release first.

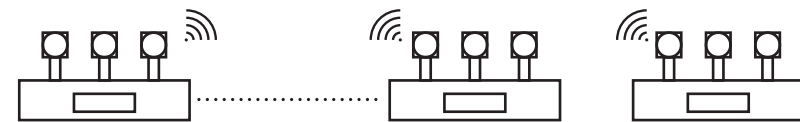

Master
-Transmitter mode

Slave
-Receiver

10 CHANNELS		
Channel	Value	Function
1	000 - 255	Master dimmer
2	000 - 255	WW
3	000 - 255	WW fine
4	000 - 255	CW
5	000 - 255	CW fine
6	000- 255	White color marco: 3000K-6000K
7	000 - 255	Strobe (slow -fast)
8	000 - 020	No function
	021 - 040	auto 1
	041 - 060	auto 2
	061 - 080	auto 3
	081 - 100	auto 4
	101 - 120	auto 5
	121 - 147	sound 1
	148 - 174	sound 2
	175 - 201	sound 3
	202 - 228	sound 4
229 - 255	sound 5	
9	000 - 255	Auto speed
10	000 - 009	No function
	010 - 029	Linear dimmer
	030- 069	Dimmer 1 (fast)
	070 - 129	Dimmer 2
	130 - 189	Dimmer 3
	190 - 255	Dimmer 4(slow)

Features

- Leds:3pcs * 4W 2 in 1 CW+WW LEDs
- WW:2500K-2700K,CW:6000K-6500K
- Power:38 W
- Working time@auto:14h
- Charging:5h
- Battery:8.4V 9A
- Power adapter:12V 3A
- CRI:90
- DMX channels:2/5/8/10 CH
- Angle:15°
- Dimensions:310 x 478 x 2018 mm
- Weight:1.11 kg
- Brightness:989 lx@2m
- Waterproof:IP20
- Wireless DMX:lumenradio wireless
- 2.4G Remote
- Mounting point:With 2 mounting points for fast locks
- Orientation:Arbitrary
- Rigging possibilities: Suspended or mounted on ceiling or wall
- Safety features: With hole for safety wire
- Easy and fast for installation with magnetic

Package Contents

- ① Light
- ② Adaptor
- ③ Connector
- ④ 2.4G Remote control
- ⑤ Power cable
- ⑥ Power supply
- ⑦ Base
- ⑧ User manual
- ⑨ Three pipes

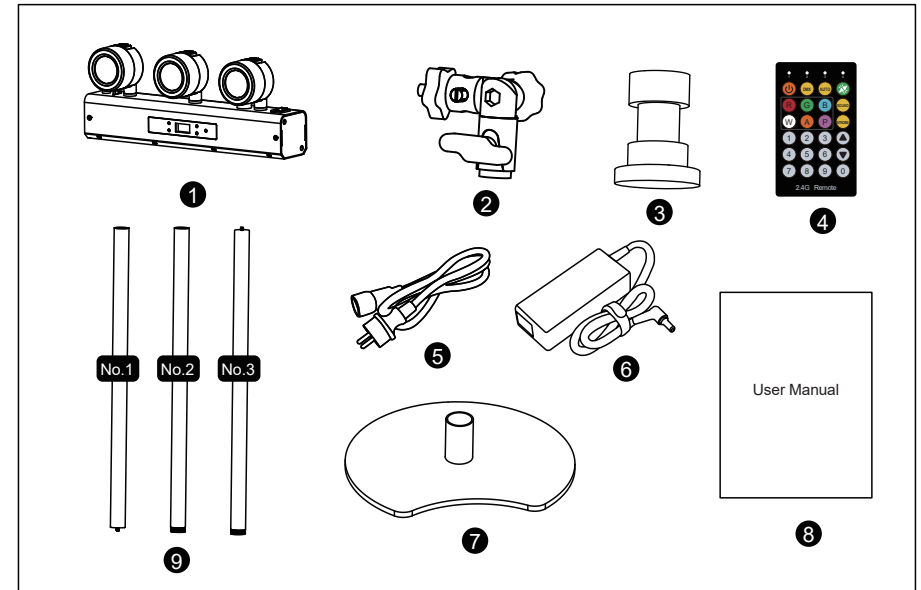

Mounting

Step 1: Insert the first pole into the base and rotate it to fix it.

Step 2: Rotate the second pole and put it fix the first pole.

Step 3: Rotate the third pole and fix it on the second pole to complete the main body.

Step 4: Rotate the adapter and fix it on the lamp.

Step 5: Rotate the connector and fix it to the third pole.

Step 6: Insert the lamp holder assembly into the connecting into the main connector, and rotate the knob to fix, complete the assembly.

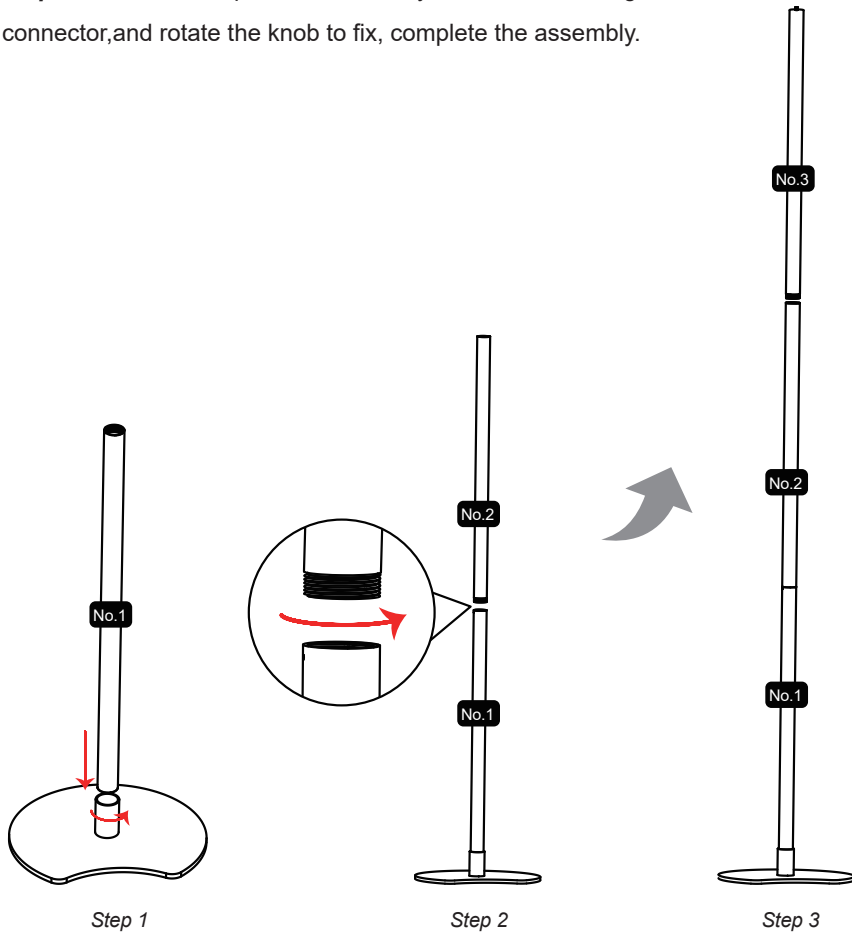

8 CHANNELS		
Channel	Value	Function
1	000 - 255	Master dimmer
2	000 - 255	WW
3	000 - 255	CW
4	000- 255	White color marco: 3000K-6000K
5	000 - 255	Strobe (slow -fast)
6	000 - 020	No function
	021 - 040	auto 1
	041 - 060	auto 2
	061 - 080	auto 3
	081 - 100	auto 4
	101 - 120	auto 5
	121 - 147	sound 1
	148 - 174	sound 2
	175 - 201	sound 3
	202 - 228	sound 4
229 - 255	sound 5	
7	000 - 255	Auto speed
8	000 - 009	No function
	010 - 029	Linear dimmer
	030- 069	Dimmer 1 (fast)
	070 - 129	Dimmer 2
	130 - 189	Dimmer 3
	190 - 255	Dimmer 4(slow)

DMX control mode

2 CHANNELS		
Channel	Value	Function
1	0-255	White color marco: 3000K-6000K
2	0-255	Strobe

5 CHANNELS		
Channel	Value	Function
1	000 - 255	Master dimmer
2	000 - 255	WW
3	000 - 255	CW
4	000 - 255	White color marco: 3000K-6000K
5	000 - 255	Strobe (slow -fast)

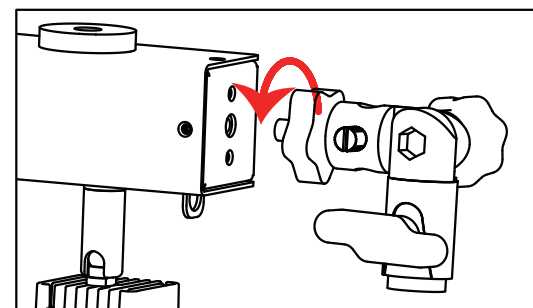

Step 4

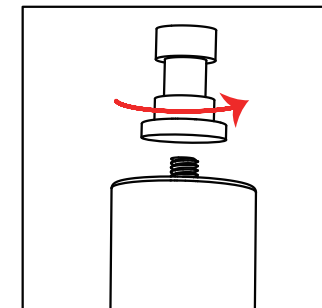

Step 5

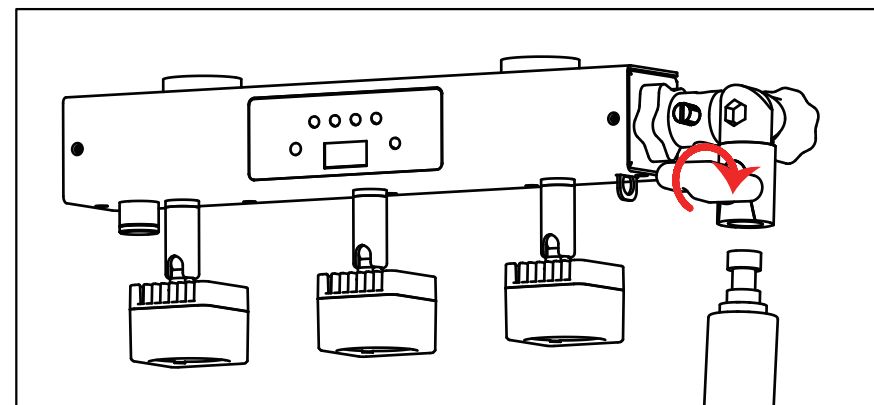

Step 6

Displayer Introduction

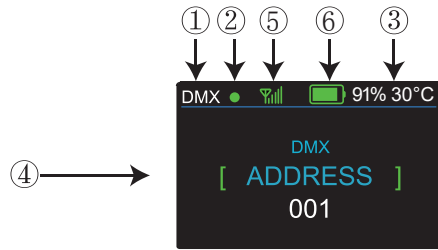

1. When you enter DMX Mode, it will be showed DMX, when you enter SLAVE Mode, it will be showed SLAVE.
2. This shows the condition of signal transmission. Green is connected. Red is disconnected.
3. This shows the temperature of the lights.
4. This shows the menus you can select.
5. This shows the condition of wireless signal. Green is connected. Red is disconnected.
6. This shows the battery's electric quantity.

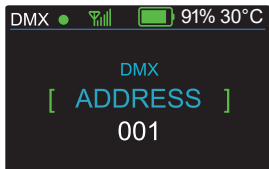

While DMX and Wireless signal are green, it means DMX Mode and Wireless are connected.

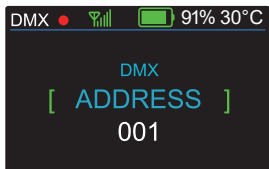

While DMX shows red but Wireless signal shows green, it means DMX Mode is disconnected and Wireless is connected.

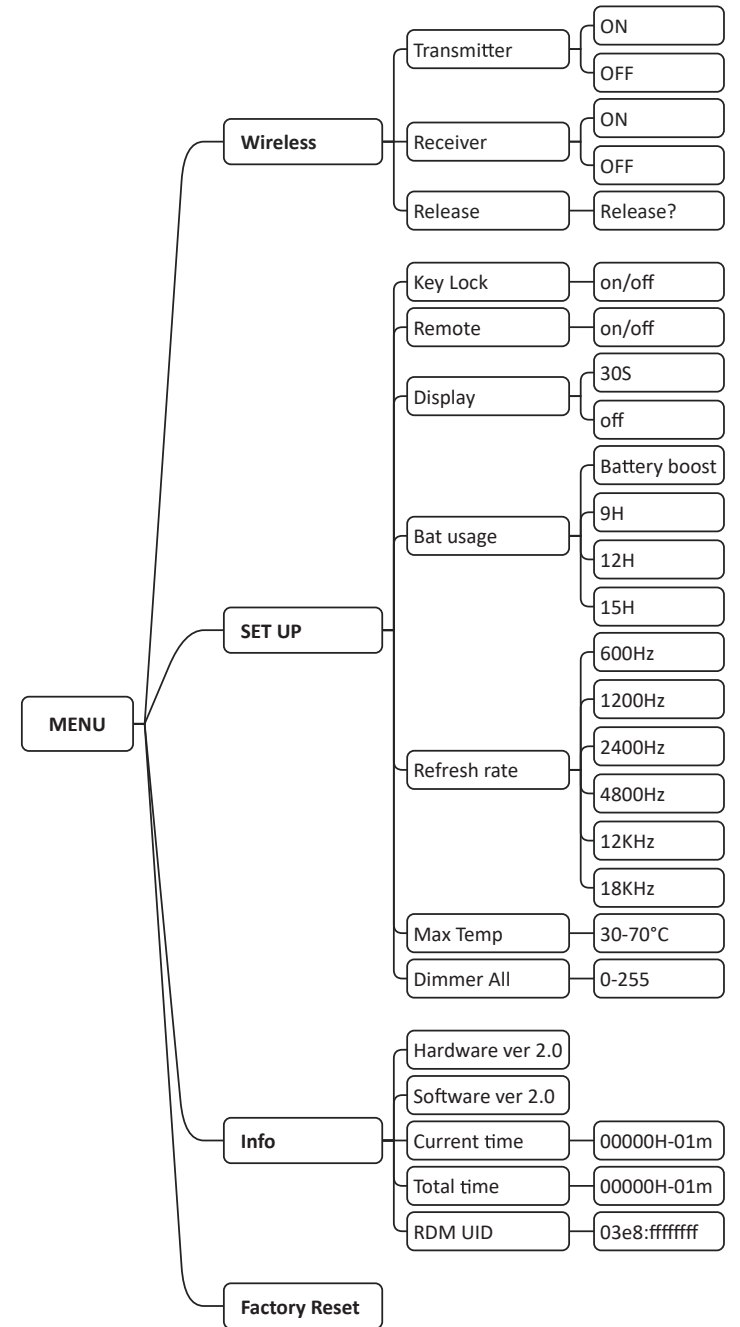

Programme Menu

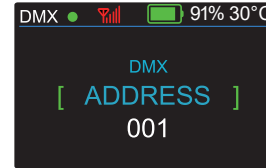
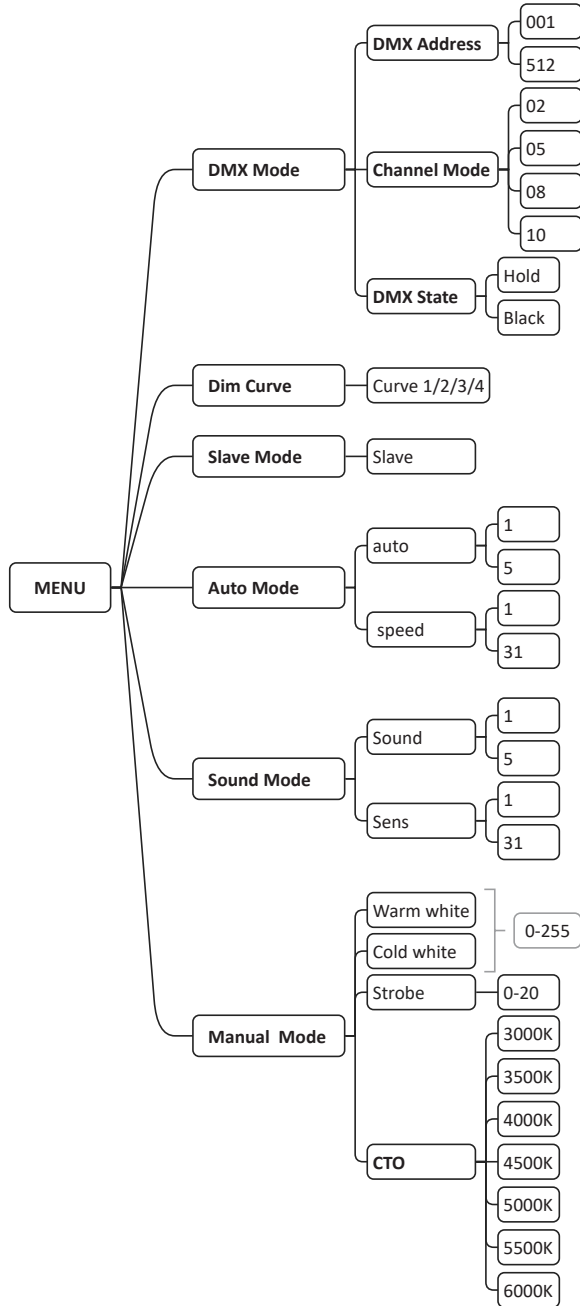

While DMX shows green but Wireless signal shows red, it means DMX Mode is connected and Wireless is disconnected.

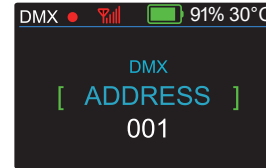

While DMX and Wireless are shown red, it means DMX Mode and Wireless are disconnected.

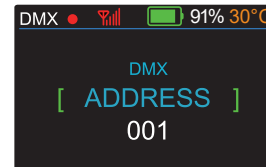

While the letters and number show change from white to yellow, it means the temperature is beyond the maximum temperature of default settings.

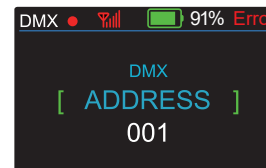

While the letters and number show Error, it means there are some temperature problems.

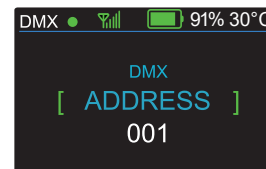

While the battery is charging, it will show running from empty to full. When you stop charging, it will show how much the electric quantity.

DMX Mode-In this menu,you can connect several pieces of lights with DMX cable and control them with control console.

- 1.Press "ENTER"button and then UP or DOWN button until "DMX Mode" is showed.
- 2.Press "ENTER"button,and "Channels Mode" "DMX Address"or "DMX State"will be showed.Then press ENTER.

- 1)"Channel [xx]"will be showed,"X"represents the showed DMX channel mode.You can press the UP or DOWN button to select your desired Channel mode.
- 2)"xxx"will be showed,"x"represents the showed address.You can press the UP or DOWN button to select your desired address.'
- 3)"Hold" or"Black"will be showed,you can press the UP or DOWN button to select your desired DMX State

Dim Curve-In this menu,you can adjust the brightness of the light .

- 1.Press "ENTER"button and then UP or DOWN button until "Dim Curve" is showed.
- 2.Press "ENTER"button,and "CURVE1" to"CURVE4"will be showed.Then press ENTER to select your desired Dim Curve.

Slave Mode-In this menu,you can select one light as the MASTER light and other lights in SLAVE mode will run following the MASTER light.

- 1.Press "ENTER"button and then UP or DOWN button until "Slave Mode"is showed.
- 2.Press "ENTER"button again to enter Slave Mode.

Auto Mode-In this menu,you can select your desire Auto Mode and adjust the running speed.

- 1.Press"ENTER"button and then UP or DOWN button until"Auto Mode"is showed.
- 2.Press"ENTER"button,and"SPEED"or"AUTO MODE"will be showed.Then press ENTER,and you can see two items as below:
 - 1)SPEED-You can select your desired speed in this menu.
 - 2)AUTO MODE-You can select your desired auto mode in this menu.

Sound Mode-In this menu,you can select your desire Sound Mode and adjust the sensitivity of the sound mode.

- 1.Press"ENTER"button and then UP or DOWN button until"Sound Mode"is showed.
- 2.Press"ENTER"button,and"Sens"or" Sound Mode"will be showed.Then press ENTER,and you can see two items as below:
 - 1)Sens-You can select your desired speed in this menu.
 - 2)Sound Mode-You can select your desired sound mode in this menu.

Manual Mode-In this menu, you can edit a scene by adjusting the value of"Warm White(0-255)", "Cold White(0-255)", "Strobe(0-20)"and"CTO(3000k-6000k)"as you like.

- 1.Press "ENTER"button and then UP or DOWN button until "Manual Mode"is showed.
- 2.Press"ENTER"button,and"Warm White", "Cold White", "Strobe"or"CTO"will be showed.Then press ENTER,and you can see four items as below:
 - 1)Warm White-You can adjust the warm white brightness in this menu.
 - 2)Cold White-You can adjust the cold white brightness in this menu.
 - 3)Strobe-You can adjust the strobe mode in this menu.
 - 4)CTO-You can adjust the color temperature in this menu.

Wireless-In this menu,you can transmit, receive or clear wireless signals.

- 1.Press"ENTER"button and then UP or DOWN button until"Wireless"is showed.
- 2.Press"ENTER"button,and"Transmitter", " Receiver"or "Release"will be showed.Then press ENTER,and you can see three items as below:

- 1)Transmitter- In this item,you can select "ON"or "OFF".If you select ON,you can use the wireless transmission function.And if you select OFF,wireless transmission will be turned off.
- 2)Receiver- In this item,you can select "ON"or "OFF".If you select ON,you can use the wireless reception function.And if you select OFF,wireless reception will be turned off.
- 3)Release-In this item, you can clear wireless signals."SUCCEESS" will be displayed when the wireless signal is successfully cleared

Set Up-In this menu,you can adjust the value of the function.

- 1.Press "ENTER"button and then UP or DOWN button until "Set Up"is showed.
- 2.Press "ENTER"button,and there will be seven options.Then,press ENTER to select the option and press UP or DOWN button to select the value you desire as below:
 - 1)Key Lock-You can select whether the password is on or off in this menu and the password is DOWN +UP]DOWN]UP].If you select"on",then you have to input the password before pressing the buttons.Otherwise,the light won't respond to your order.
 - 2)Remote-If you select"on",you can connect 2.4G remote control.On the contrary, the remote control function will be disabled.
 - 3)Display-In this item,you can select "30s"or "OFF".If you select ON,the displayer will be on all the time.And if you select 30s,the screen will turn off after 30 seconds.
 - 4)Bat Usage-You can select the battery usage mode.Battery boost is the most power-hungry mode and 15H is the most power-saving mode.
 - 5)Refresh Rate-You can select the refresh rate from 600Hz to 18k Hz.
 - 6)Max temp You can set the your desired Max working temperature about the light in this menu.When the working temperature of the light exceeds the Max temperature,the color of letter"Temp xx"showed in the menu will change from white to yellow.Meanwhile,the light will adjust the working temperature automatically.
 - 7)Dimmer All-You can adjust the brightness of each color in this menu.

Info-In this menu,you can learn about the information of software,hardware,the working time of the light and the RDM UID number of the light.

- 1.Press "ENTER"button and then UP or DOWN button until "Info"is showed.
- 2.Press"ENTER"button,and"Software ver""Hardware ver", "Current Time", "Total Time" and "RDM UID"will be showed.Then press ENTER,and you can see five items as below:
 - 1)Software ver-This item displays the Software information.
 - 2)Hardware ver-This item displays the Hardware information.
 - 3)Current times-This item displays the current working hours of the light.
 - 4)Total times-This item displays the total working hours of the light.
 - 5)RDM UID-This item displays the RDM UID number of the light.

Factory Reset-In this menu,you can reset all the value of the system.

- 1.Press"ENTER"button and then UP or DOWN button until"Factory Reset"is showed.
- 2.Press the ENTER button to reset all the value of the system.