

EVF-1152S/94

Single 15" Two-Way 90° x 40° Full-Range Loudspeaker System



Key Features:

- ND2B 2" (51mm) Diaphragm, 1.4" (36mm) Exit Pure Titanium Compression Driver
- SMX2151 15" (381mm) LF Transducer with Fully Symmetric Drive
- Advanced 4th Order Crossover Network with HF Protection
- Coverage Pattern: 90° x 40° Constant Directivity™ 12" Rotatable Waveguide
- 101 dB Sensitivity, 134 dB Maximum SPL
- System Rating: 500W Continuous, (2000W Peak)
- Active Rating: LF400W/HF40W Continuous (1600W/160W Peak)
- (22) M10 Threaded Suspension Points
- PI Version Available with Gland Nut and Stainless Steel Grille

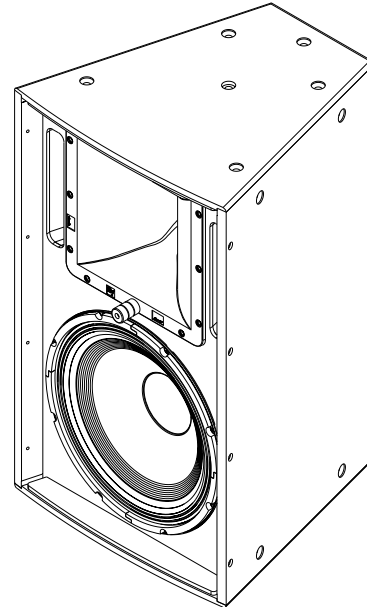

General Description:

The Electro-Voice® EVF-1152S/94 is a high power, 2-way loudspeaker system that can be used in a variety of applications where high quality sound reinforcement is required in a compact, light-weight package.

The EVF-1152S/94 utilizes the ND2B, a high output 2" titanium compression driver, coupled to a Constant Directivity™ 90° x 40° waveguide. The SMX2151 15" woofer used FEA optimization for motor, suspension, and electrical design for very low distortion, high efficiency, and maximum intelligibility at high SPL levels. The crossover uses steep 24 dB/octave slopes with equalization for very smooth response in vocal range, linear off-axis response, and a protection circuit for long term reliability.

The EVF-1152S/94 features make it ideal for many fixed install applications. The trapezoidal enclosure is constructed out of weather resistant birch, and coated with EVCoat™ for maximum protection from the elements. The unique acoustic and rigging design allows for vertical and horizontal clusters to be built using any combination of loudspeakers from the entire EVF & EVH Series, with 7 horn patterns to choose from and an assortment of Low Frequency and subwoofer loudspeakers, it gives you the tools to maximize flexibility of system design, no matter what the application and budget. The innovative input panel provides choice of phoenix style connector (included in all standard models) or the ability to add; a dual NL4 type connector cover plate or gland nut cover plate (for weatherizing applications). An externally accessible jumper selects passive or active operation. An available 70.7/100 Volt transformer kit simply mounts to the input panel for use in distributed systems. All these features give you the flexibility to do a large range of venues with fewer items in inventory and quickly support your customer's requirements.

Technical Specifications:

Freq. Response ¹ (-3 dB):	70 Hz - 14 kHz	
Freq. Range ¹ (-10 dB):	41 Hz - 18 kHz	
Rec. Hipass Frequency:	45 Hz	
Axial Sensitivity:	101 dB (1W/1m)	
Max. Calculated SPL:	134 dB	
Horizontal Coverage:	90° (or 40°)	
Vertical Coverage:	40° (or 90°)	
Power Handling:	500W Continuous, 2000W Peak	
LF Transducer:	SMX2151, 15 in (381mm) Driver	
HF Transducer:	ND2B, 2 in (51mm) Diaphragm Compression Driver	
Crossover Frequency:	1450 Hz	
Nominal Impedance:	8 Ohms	
Minimum Impedance:	6.0 Ohms	
Connectors:	(2) 4 Contact 10 AWG Phoenix/ EuroBlock Style Screw Terminal	PI Version - Gland Nut with Included Input Panel Cover
Enclosure Material:	13 Ply Weather Resistant Birch	
Grille:	16 GA Galva- nneal, Powder- coat, with Rotat- able Logo	PI Version - Stainless Steel with Hydropho- bic Cloth
Suspension:	(22) M10 Threaded Points	
Dimensions (H x W x D):	30.26" x 18.50" x 18.37" (768.6mm x 469.8mm x 466.6mm)	
Net Weight:	70.9 lb (32.1 kg)	
Shipping Weight:	81.2 lb (36.8 kg)	

¹ Half Space Measurement.



EVF-1 152S/94 Loudspeaker System

Frequency Response & Impedance:

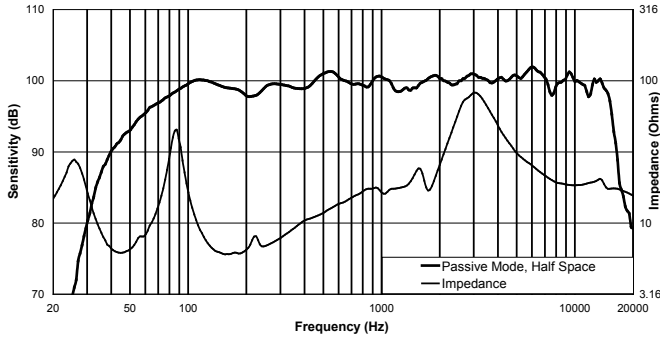

Horizontal Off Axis Frequency Response:

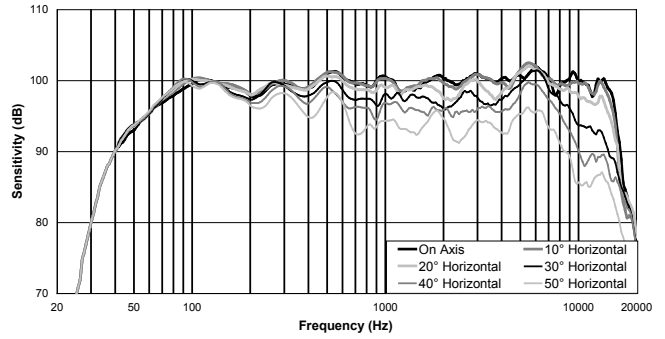

Vertical Off Axis Frequency Response (Up):

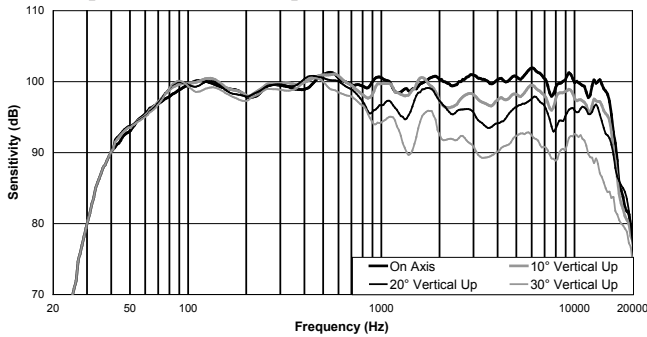

Vertical Off Axis Frequency Response (Down):

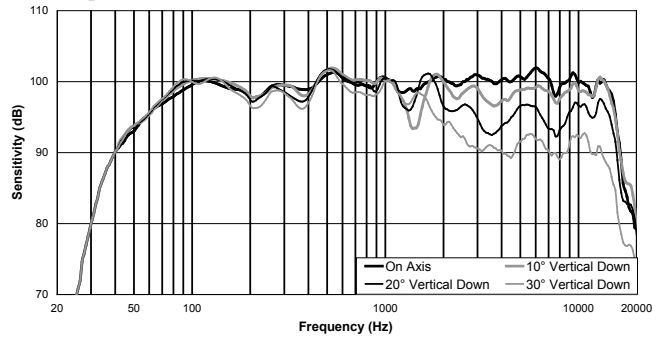

Beamwidth:

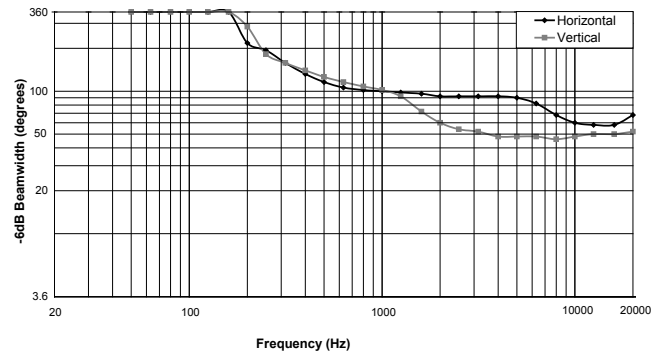

Directivity:

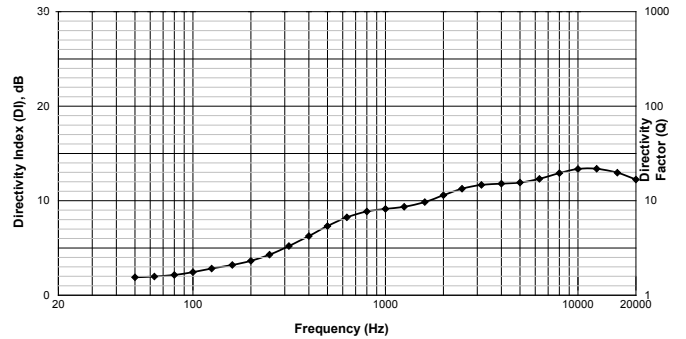

Block Diagram (Biamp):

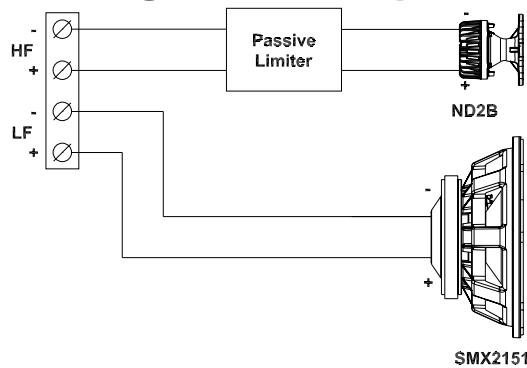

Block Diagram (Passive):

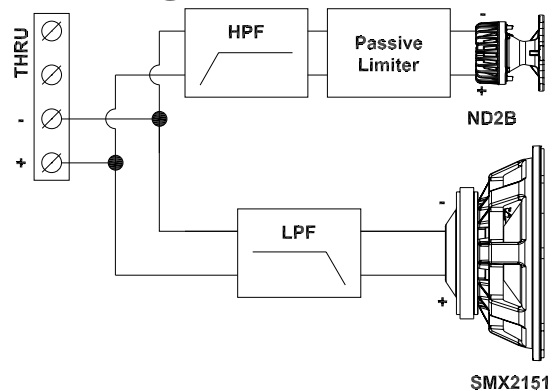

Polar Plots (1/3 Octave):

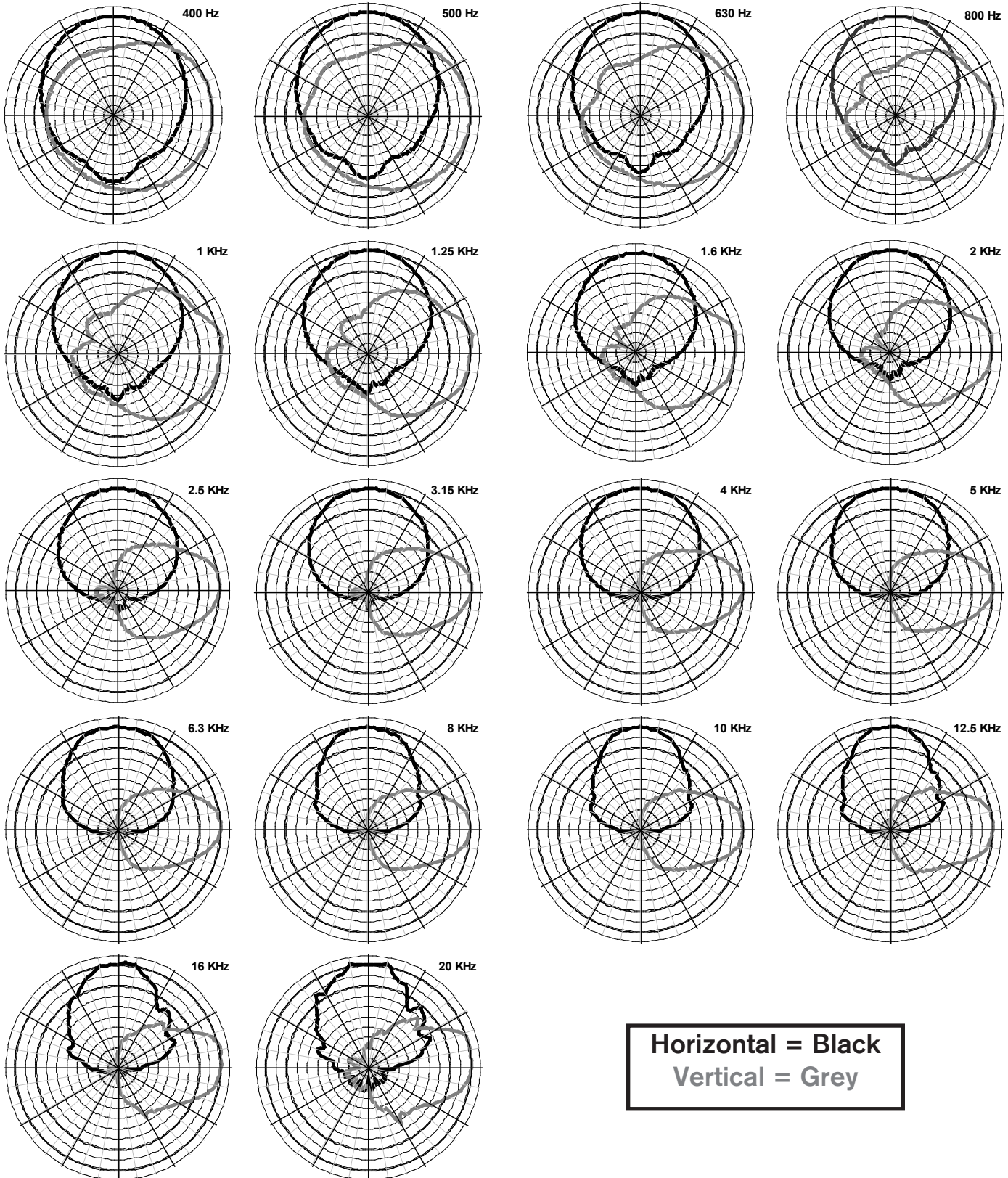

Dimension Drawings:

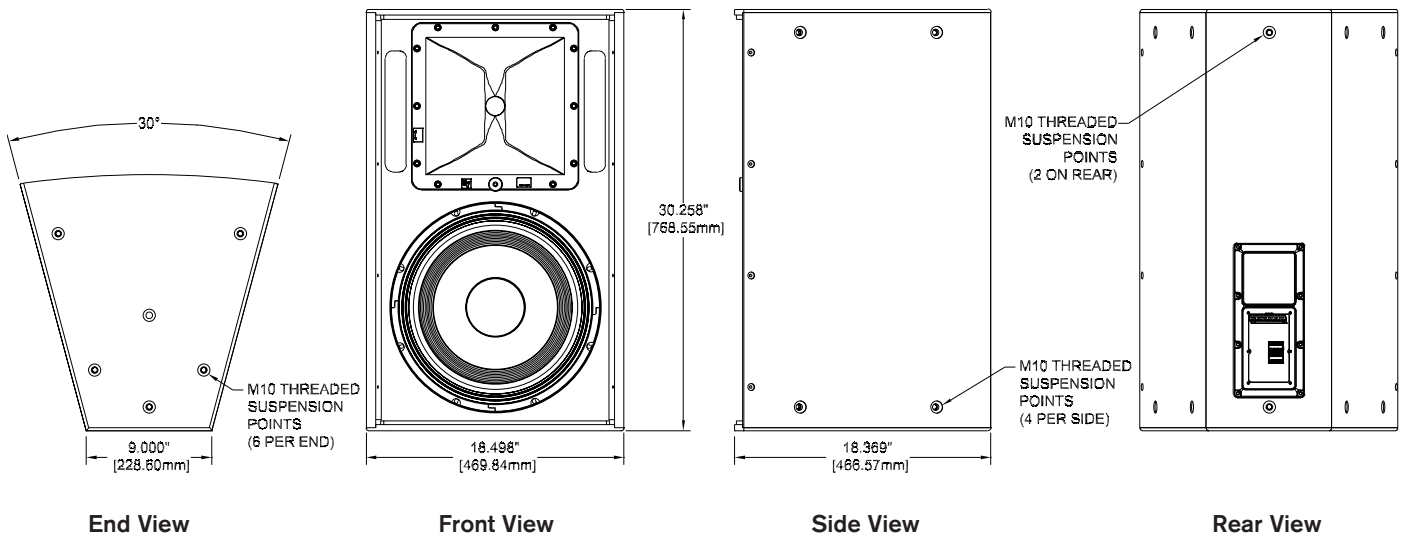

EVF-1152S/94 Product Descriptions

- EVF-1152S/94-BLK, 90° x 40°, Black Finish
- EVF-1152S/94-WHT, 90° x 40°, White Finish
- EVF-1152S/94-PIB, 90° x 40°, Black Finish, Weather Resistant
- EVF-1152S/94-PIW, 90° x 40°, White Finish, Weather Resistant
- EVF-1152S/94-FGB, 90° x 40°, Black Finish, Weather Resistant Fiberglass
- EVF-1152S/94-FGW, 90° x 40°, White Finish, Weather Resistant Fiberglass



CAUTION

This EVF Loudspeaker should be suspended overhead only in accordance with the procedures and limitations specified in the *EVF/EVH Users Manual* and possible manual update notices. This system should be suspended with certified rigging hardware by an authorized rigging professional and in compliance with local, state, and federal overhead suspension ordinances.

Performance Match

- EVF-1122S/64, 60° x 40° Coverage
- EVF-1122S/66, 60° x 60° Coverage
- EVF-1122S/94, 90° x 40° Coverage
- EVF-1122S/96, 90° x 60° Coverage
- EVF-1122S/99, 90° x 90° Coverage
- EVF-1122S/126, 120° x 60° Coverage
- EVF-1152S/43, 40° x 30° Coverage
- EVF-1152S/64, 60° x 40° Coverage
- EVF-1152S/66, 60° x 60° Coverage
- EVF-1152S/96, 90° x 60° Coverage
- EVF-1152S/99, 90° x 90° Coverage
- EVF-1121S, 12" Bass Element
- EVF-1151S, 15" Bass Element
- EVF-1181S, 18" Bass Element
- CPS2.9, 120V Power Amplifier, 2 x 900W
- CPS2.12, 120V Power Amplifier, 2 x 1200W
- CPS4.5, 120V Power Amplifier, 4 x 500W
- CPS4.10, 120V Power Amplifier, 4 x 1000W

Accessories

- CDNL4, Cover Plate, Dual NL4
- CSG, Cover Plate, Single Gland Nut
- CDG, Cover Plate, Dual Gland Nut
- TK-150, 70V Transformer, 150W
- HRK-1B, Horiz. Rigging Kit, EVF, Black
- HRK-1W, Horiz. Rigging Kit, EVF, White
- HRK-2B, Horiz. Rigging Kit, EVF-SUB, Black
- HRK-2W, Horiz. Rigging Kit, EVF-SUB, White
- VRK-1B, Vert. Rigging Kit, EVF, Black
- VRK-1W, Vert. Rigging Kit, EVF, White
- VRK-2B, Vert. Rigging Kit, EVF-SUB, Black
- VRK-2W, Vert. Rigging Kit, EVF-SUB, White
- EVF-UB-BLK, U-Bracket Kit, EVF, Black
- EVF-UB-WHT, U-Bracket Kit, EVF, White

Electro-Voice®

12000 Portland Avenue South, Burnsville, MN 55337
Phone: 952/884-4051, Fax: 952/884-0043

www.electrovoice.com

© Bosch Communications Systems 05/2011

Part Number F.01U.196.178 Rev 02

U.S.A. and Canada only. For customer orders, contact Customer Service at
800/392-3497 Fax: 800/955-6831

Europe, Africa, and Middle East only. For customer orders, contact Customer Service at:
+ 49 9421-706 0 Fax: + 49 9421-706 265

Other International locations. For customer orders, Contact Customer Service at:
+ 1 952 884-4051 Fax: + 1 952 887-9212

For warranty repair or service information, contact the Service Repair department at:
800/685-2606

For technical assistance, contact Technical Support at: 866/78AUDIO

Specifications subject to change without notice.