

# EVC-1082-00 8" speaker 100x100

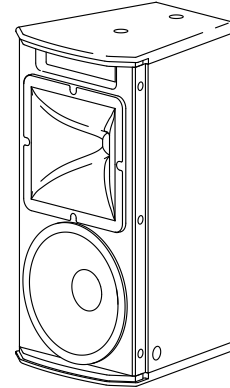

**Electro-Voice**

- 8-inch, two-way loudspeaker, with 100° x 100° constant directivity, rotatable waveguide
- Power rating: 200 W Continuous, (800 W Peak)
- Passive system: 91 dB, 120 dB maximum
- Gland nut cover and stainless steel grille on PI versions
- Optional high quality transformer and patented Automatic Saturation Control (ASC) preserve low end in 70V/100V lines



EVC loudspeakers from Electro-Voice are two-way systems that can be used in a broad range of applications where wide bandwidth, vertical and horizontal directivity control, and high efficiency are required in a compact, cost-effective package. EVC loudspeakers are voiced to complement other EV-Innovation models (EVF, EVH, EVA). The high frequency section of EVC loudspeakers comprises a single 1¼-inch pure titanium dome compression driver directly coupled to a rotatable constant directivity waveguide that delivers uniform pattern control and smooth, linear response. The low frequency section employs a high-output woofer that was developed using state-of-the-art, computer aided optimization to provide low distortion, high efficiency, and maximum intelligibility at high sound pressure levels. The passive crossover implements a fourth-order Linkwitz Riley design with slopes of 24 dB per octave for smooth off axis response and improved definition through the critical vocal range. The EVC series is an extremely cost effective solution for many fixed-install applications. The enclosures are constructed of 15-mm plywood and finished with EVCoat for enhanced durability. The loudspeakers have been designed with multiple M10 rigging points as well as attachment points for an optional U-bracket or multi-mount style pan/tilt wall mount. All EVC series loudspeakers accept wire gauges up to 10 AWG. The input panel also accepts optional covers with NL4-type connectors or weatherized gland-nuts.

For 70V/100V operation, the input panel has an internal landing pad for mounting EV's high-quality TK150 audio transformer. Adding a TK150 to the EVC input panel engages EV's patented Automatic Saturation Compensation (ASC), which preserves low frequency performance while presenting a stable load to the amplifier regardless of how many loudspeakers are connected in parallel. This results in transformer and non-transformer EVC loudspeakers that sound virtually identical.

## Technical specifications

|   |                                  |
|---|----------------------------------|
| Frequency response (-3 dB) <sup>1,3</sup> : | 75 Hz - 20 kHz                   |
| Frequency range (-10 dB) <sup>1,3</sup> :   | 55 Hz - 25 kHz                   |
| Rotatable coverage:                         | 100° x 100°                      |
| Rec. high-pass frequency:                   | 50 Hz                            |
| Passive crossover frequency:                | 1.85 kHz                         |
| Axial sensitivity <sup>1</sup> :            | 91 dB (1 W/1 m)                  |
| Max. calculated SPL <sup>1</sup> :          | 120 dB                           |
| Power handling <sup>2</sup> :               | 200 W (Continuous), 800 W (Peak) |
| Nominal impedance:                          | 8 Ω                              |
| Minimum impedance:                          | 6 Ω                              |

2 | EVC-1082-00 8" speaker 100x100

|                         |   |  |
|-------------------------|---|--|
| LF transducer:          | EVS-2008  |  |
| HF transducer:          | DH-2005   |  |
| Connectors:             | Dual four-pin 10 AWG Phoenix/<br>Euro Block screw-terminals |  |
| Enclosure:              | 15-mm plywood with EVCoat                                   |  |
| Grille:                 | 18 GA<br>powder-<br>coated steel<br>with rotatable<br>logo  | PI version: 18<br>GA stainless<br>steel with<br>hydrophobic<br>cloth |
| Environmental:          | IEC 60529,<br>IP44  | PI version: IEC<br>60529, IP55                                       |
| Suspension:             | (8) M10 suspension points                                   |  |
| Color:                  | Black or white  |  |
| Dimensions (H x W x D): | 492 mm x 248 mm x 277 mm<br>(19.38 in x 9.76 in x 11.01 in) |  |
| Net weight:             | 11.2 kg (24.8 lb)   |  |
| Shipping weight:        | 12.7 kg (28.0 lb)   |  |

<sup>1</sup>Full-space measurement.

<sup>2</sup>EIA RS-426A, tested for eight hours.

<sup>3</sup>With recommended preset.

**Frequency response and impedance:**

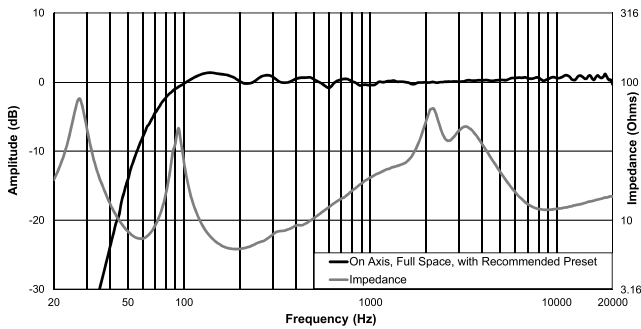

**Horizontal off-axis frequency response:**

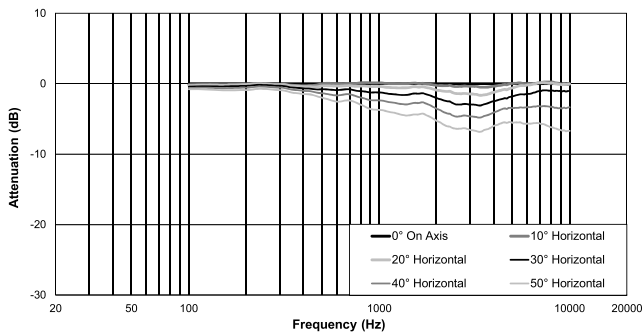

**Vertical off-axis frequency response (down):**

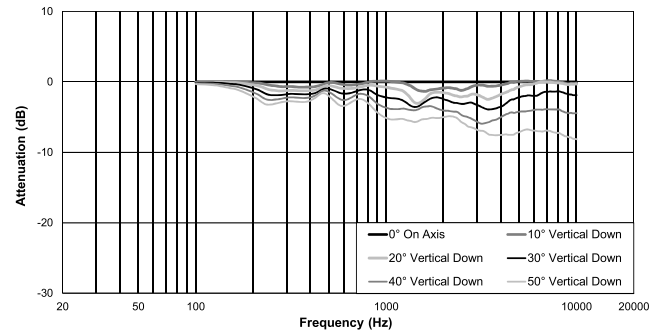

**Vertical off-axis frequency response (up):**

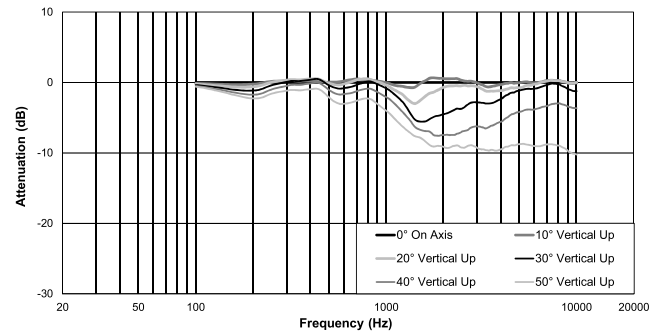

**Beamwidth:**

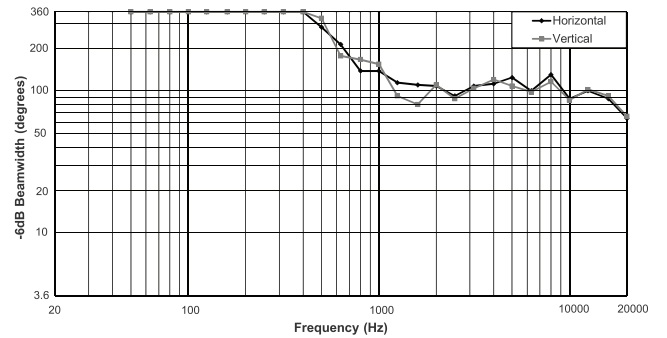

**Dimensions:**

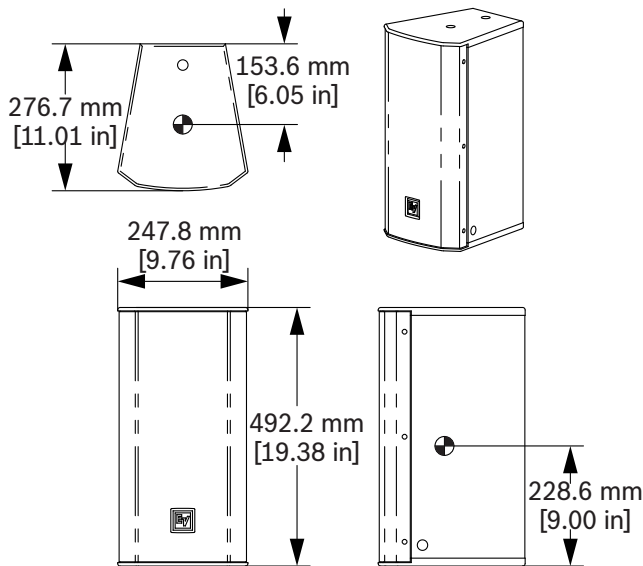

**Architectural and engineering specifications:**

The loudspeaker shall be a two-way passive system with Euro block input connectors that accept wire sizes up to AWG 10. The two Euro block connectors on the input panel should be configured for a speaker-level, two-conductor input that is connected in parallel to terminals on a second Euro block connector so that additional loudspeakers can be connected in parallel. The remaining pair of terminals on each of the two connectors should be configured for a pass-through audio connection. The input panel should also be able to accept NL4-type connectors or be adapted for weather-proof single or dual gland nuts when fitted with an accessory input adapter plate. The input panel should include a landing pad and appropriate electrical connections on the inside of the loudspeaker cabinet so that the installer can mount and connect a high-quality audio transformer in series with the direct low-impedance connection to the loudspeaker dividing network. When the transformer is installed, the input circuit network shall be augmented with a high-pass filter with a current-dependent corner frequency in order to preserve the full bass response of the loudspeaker while protecting system amplifiers from the drop in load impedance that commonly occurs when audio transformers are driven into saturation. High frequency waveguides shall be rotatable and should be labeled with their horizontal and vertical coverage angles for easy identification of the current orientation. The passive dividing network shall employ an enhanced 4th-order filter topology with response-shaping equalization and high frequency protection, resulting in acoustical crossover slopes of 24 dB per octave or steeper. The system shall have an 8-inch low-frequency transducer with a nominal impedance of 8 ohms, a 2-inch diameter voice coil. System continuous

average power rating shall be 200 watts (per ANSI/EIA RS-426 A). The high-frequency section shall employ a compression driver with a 1.25-inch voice coil and 1.25-inch titanium diaphragm, mounted on a 100° horizontal by 100 vertical waveguide. The loudspeaker enclosure shall be constructed of 15 mm plywood, shall be trapezoidal in shape, and be finished with a polyurea coating. The grille shall be constructed from 18 GA powder-coated cold-rolled steel backed with acoustically transparent fabric [PI: 18 GA stainless steel backed with acoustically transparent hydrophobic cloth]. The system shall be capable of high-level operation with a bandwidth of 75 Hz to 20 kHz (-3 dB down point). The system dimensions shall be 247.8 mm (9.76 in) wide by 492.2 mm (19.38 in) high by 276.7 mm (11.01 in) deep. The system shall employ facilities for mounting with a U-bracket or pan/tilt wall bracket, as well as facilities for suspension from M10 mounting points. Net weight shall be 11.2 kg (24.8 lb). The loudspeaker shall be the EVC-1082-00B, EVC-1082-00W, EVC-1082-00PIB, or EVC-1082-00PIW models from Electro-Voice.

**Compatible System Solutions, Electronics:**

L1300FD DSP power amplifier 2x650W

C1300FDi DSP power amplifier 2x650W, install

**Ordering information**

**EVC-1082-00B 8" speaker, 100x100 indoor, black**

Two-way compact loudspeaker system, IP44, EVCoat black  
Order number **EVC-1082-00B**

**EVC-1082-00W 8" speaker, 100x100 indoor, white**

Two-way compact loudspeaker system, IP44, EVCoat white  
Order number **EVC-1082-00W**

**EVC-1082-00PIB 8" speaker, 100x100 weatherized, black**

Two-way compact loudspeaker system, IP55, weather-resistant black  
Order number **EVC-1082-00PIB**

**EVC-1082-00PIW 8" speaker, 100x100 weatherized, white**

Two-way compact loudspeaker system, IP55, weather-resistant white  
Order number **EVC-1082-00PIW**

**Accessories**

**EVC-UB1-BLK U-Bracket EVC 8" black**

U-Bracket fits EVC-1082 loudspeakers, black finish  
Order number **EVC-UB1-BLK**

**EVC-UB1-WHT U-Bracket EVC 8" white**

U-Bracket fits EVC-1082 loudspeakers, white finish  
Order number **EVC-UB1-WHT**

4 | EVC-1082-00 8" speaker 100x100

**EVC-WB-BLK Wall bracket EVC 8",12",15" black**

OmniMount style pan/tilt loudspeaker mount, black  
Order number **EVC-WB-BLK**

---

**EVC-WB-WHT Wall bracket EVC 8",12",15" white**

OmniMount style pan/tilt loudspeaker mount, white  
Order number **EVC-WB-WHT**

---

**CDG-LB**

Dual gland nut cover kit for EVA, EVC, EVF & EVH  
Order number **CDG-LB**

---

**CDNL4-LB**

Dual NL4 cover kit for EVA, EVC, EVF & EVH, black  
Order number **CDNL4-LB**

---

**CSG-LB**

Single gland nut cover kit for EVA, EVC, EVF & EVH,  
black  
Order number **CSG-LB**

---

**EBK-M10-3PACK**

Forged M10 eyebolt kit, set of 3  
Order number **EBK-M10-3PACK**

---

**TK-150**

Transformer kit for EVC, EVF, and EVH, 150W/70V  
Order number **TK-150**

---

**Represented by:**

---

**Germany:**

Bosch Sicherheitssysteme GmbH  
Robert-Bosch-Ring 5  
85630 Grasbrunn  
Germany

Bosch Security Systems, Inc.  
12000 Portland Avenue South  
Burnsville MN 55337  
USA

[www.electrovoice.com](http://www.electrovoice.com)